



Número de artículo: DMK8

## Multi-dimmer externo - 5m

El cable atenuador DMK8 es una solución ideal para ajustar el brillo de las pantallas de Beetronics, sin depender de los botones de operación o el mando a distancia.

- ✓ Ajusta hasta 5 pantallas simultáneamente
- ✓ Ajusta el brillo de la retroiluminación de 1 a 100 %
- ✓ Rápido y fácil de instalar
- ✓ Compatible con todos los monitores Beetronics



## Características generales

Fabricante	Beetronics
Nombre del producto	Multi-dimmer externo - 5m
Número de artículo	DMK8
Garantía	2 años

## Mecánico

Peso	500 gramos
Color	Negro
Longitud del cable	500 cm

## Contenido del paquete

Contiene	Multi-dimmer
----------	--------------

## Compatibilidad

Compatible con	7HD7M, 8VG7M, 8HD7M, 9HD7M, 10HD7, 10VG7M, 10HD7M, 12HD7, 12VG7M, 12HD7M, 12SDI7M, 13HD7, 13HD7M, 15HD7, 15VG7M, 15HD7M, 15SDI7M, 17HD7M, 17VG7M, 19VG7M, 19HD7M, 22HD7M, 22SDI7M, 24HD7M, 27HD7M, 32HD7M, 7TS7M, 8TSV7M, 10TS7, 10TSV7M, 10TS7M, 12TS7, 12TSV7M, 12TS7M, 13TS7, 13TS7M, 15TS7, 15TSV7M, 15TS7M, 17TSV7M, 17TS7M, 19TSV7M, 19TS7M, 22TS7M, 24TS7M, 27TS7M, 32TS7M
----------------	---



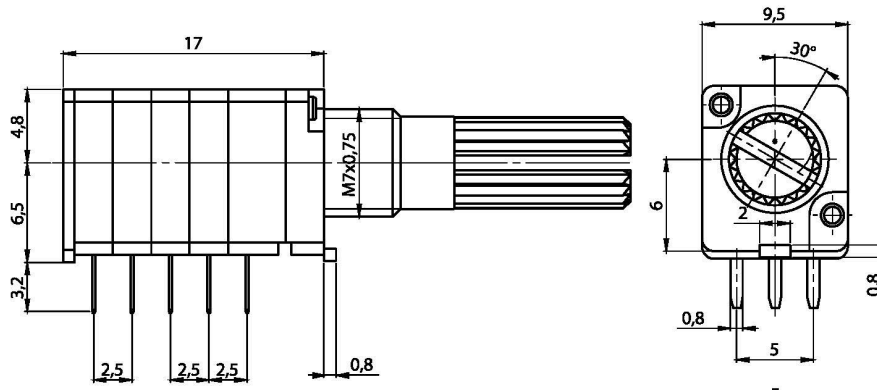

Total Resistance:  $\approx 500\text{K}\Omega$

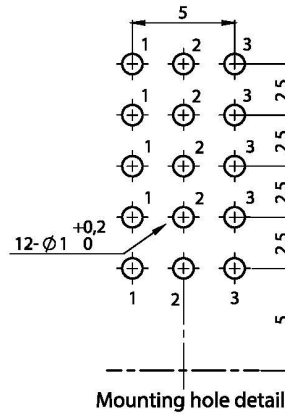
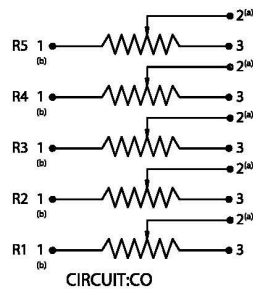
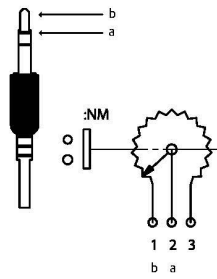

WASHER

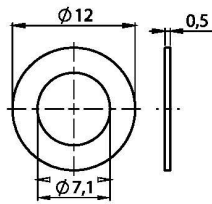

NUT

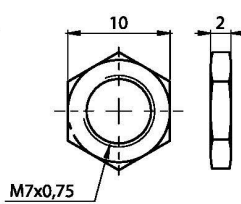

KNOB

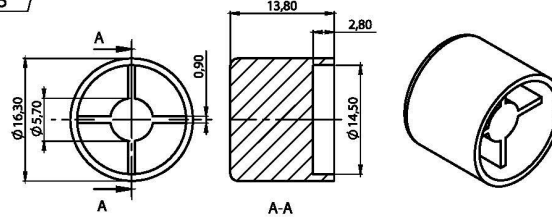

DMK8