

# User Manual

**Monitor Series**

Models

7HD7M–32HD7M  
7VG7M–19VG7M

Language  
Version  
Date

English  
1.5.1  
03-03-2026



# Table of Contents

<b>1. Scope and Intended Use</b> .....	<b>4</b>
1.1 Professional Component Classification .....	5
1.2 Intended Audience .....	5
1.3 Scope of Documentation and Allocation of Responsibility .....	5
1.4 Product Traceability .....	6
1.5 Language and Documentation Availability .....	6
<b>2. Safety Information</b> .....	<b>7</b>
2.1 Safety Symbols and Signal Words .....	8
2.2 Electrical Safety .....	8
2.3 Power Supply and Electrical Components .....	8
2.4 Restrictions on Use in Safety-Critical Systems .....	9
2.5 Environmental and Handling Precautions .....	9
2.6 Accessories and Modifications .....	9
2.7 General Safety Instructions .....	9
<b>3. Mechanical Installation &amp; Mounting</b> .....	<b>10</b>
3.1 Delivery Inspection and Package Contents .....	11
3.2 Installation Site Requirements .....	12
3.3 Mounting Methods .....	13
3.4 Compass Safe Distance (Maritime Installations) .....	18
<b>4. Electrical &amp; System Integration</b> .....	<b>19</b>
4.1 Power Supply Requirements .....	20
4.2 DC Power Integration .....	20
4.3 Grounding and Isolation .....	20
4.5 Initial Installation & Connection Overview .....	21
4.6 Foreseeable Misuse and Integration Risks .....	21
<b>5. Operation &amp; USB Media Playback</b> .....	<b>22</b>
5.1 Remote Control .....	23
5.2 Physical Control Buttons .....	24
5.3 OSD Menu .....	26
5.4 USB Media Playback .....	31
<b>6. Maintenance, Cleaning &amp; Burn-in Prevention</b> .....	<b>33</b>
6.1 Maintenance and Handling Guidelines .....	34
6.2 Cleaning Instructions .....	34
6.3 Image Retention (Burn-In) Prevention .....	34
6.4 Environmental Operating Limits .....	34
<b>7. Troubleshooting &amp; FAQ</b> .....	<b>35</b>
7.1 Troubleshooting .....	36
7.2 Frequently Asked Questions (FAQ) .....	38
<b>8. Regulatory Notices</b> .....	<b>39</b>
8.1 FCC Compliance (United States) .....	40
8.2 ISED Compliance (Canada) .....	40
8.3 Regional Compliance Scope .....	40
8.4 System-Level Regulatory Responsibility .....	40
8.5 Regulatory Contact Information .....	40
<b>9. Warranty &amp; Contact Information</b> .....	<b>41</b>
9.1 Limited Warranty .....	42
9.2 Warranty Exclusions .....	42
9.3 Limitation of Liability .....	42
9.4 Service and Support Contacts .....	43
<b>10. Appendix</b> .....	<b>44</b>



Scope and Intended Use

# 1. Scope and Intended Use

» *This chapter defines the intended application context of the product, the professional audience for whom this manual is written, and the allocation of responsibilities between Beetronics and the system integrator.*

## 1.1 Professional Component Classification

This product is classified and supplied exclusively as an unintegrated professional display component. It is engineered for integration into commercial and industrial environments by professional entities.

The product is not supplied as a finished consumer device and is not intended for standalone consumer use. It is designed to be integrated into a broader system architecture by qualified professionals.

## 1.2 Intended Audience

This manual is intended for professional users, including qualified electrical and mechanical installers, system integrators, engineering departments, and Original Equipment Manufacturers (OEMs). Electrical and mechanical integration shall be performed by qualified professionals in accordance with the requirements of the final application, applicable standards, and local regulations.

## 1.3 Scope of Documentation and Allocation of Responsibility

This documentation is provided to support professional system integration and evaluation activities. It describes the display component in its delivered configuration.

This manual does not represent approval, certification, or suitability of any complete system or end-use application, including but not limited to vehicles, maritime vessels, railway systems, medical devices, or other regulated installations.

Final system-level compliance, risk assessment, regulatory approval, and conformity with applicable directives or standards remain the sole responsibility of the system integrator, OEM, or end manufacturer.

The following fall outside the scope of this component-level documentation:

- Environmental conditions of the final installation.
- Enclosure design.
- Power distribution architecture.
- Grounding schemes.
- Cabling configuration.
- EMC behavior within the complete system.
- Any sector-specific certifications.

## 1.4 Product Traceability

Each unit is identified by a unique serial number located on the product label. The serial number serves as the primary identifier for product traceability, warranty processing, service support, and safety-related inquiries. Users are advised to record the serial number and retain it for future reference.

### Product Label Location

Label shown represents a fully populated regulatory configuration. Actual markings may vary depending on the specific model, hardware revision, intended market, and sector-specific approval.



## 1.5 Language and Documentation Availability

This manual is provided in English as the primary reference document. Safety instructions are available in the official language(s) of the country where the product is made available, in accordance with applicable regulatory requirements. Users are responsible for ensuring that the documentation used during installation and integration is appropriate for the intended market and application.





Safety Information

# 2. Safety Information

» This chapter describes safety-related information that must be observed during installation, integration, operation, and maintenance of the display component. Failure to follow these instructions may result in personal injury, equipment damage, malfunction, or non-compliance of the final system.

## 2.1 Safety Symbols and Signal Words

Safety-related information in this manual is identified by standardized signal words and symbols.

 <b>DANGER</b>	Danger	Imminently hazardous situation which, if not avoided, will result in death or serious injury.
 <b>WARNING</b>	Warning	Potentially hazardous situation which, if not avoided, could result in death or serious injury.
 <b>CAUTION</b>	Caution	Hazardous situation which, if not avoided, could result in minor or moderate injury.
<b>NOTICE</b>	Notice	Information related to property damage or operational issues. The safety alert symbol is not used with this signal word.

---

## 2.2 Electrical Safety

 **WARNING**

### Risk of Electric Shock and Fire ⚡

- Dangerous voltages may be present inside the display enclosure.
- Do not open or disassemble the display. The unit contains no user-serviceable parts.
- Do not expose the display to rain, water, or excessive humidity.
- Service and repairs must be performed by qualified personnel only.
- Failure to observe these precautions may result in serious injury or equipment damage.

## 2.3 Power Supply and Electrical Components

 **WARNING**

### Use of Approved Power Components Only

- Operate the display only with the power supply specified or supplied by Beetrionics for the applicable model.
- Use of unapproved or modified power supplies may introduce safety risks and affect evaluated configurations.
- For sector-specific configurations requiring defined compliance frameworks, the corresponding Beetrionics power supply must be used as specified for that configuration.

Use of unregulated or third-party DC power sources falls outside the evaluated safety configuration and is the responsibility of the system integrator.



## 2.4 Restrictions on Use in Safety-Critical Systems

### WARNING

#### Not a Safety Component

- Death or serious personal injury
- Catastrophic property damage
- Environmental damage

Examples include, but are not limited to:

- Life-supporting or life-sustaining medical systems
- Emergency or fail-safe systems
- Primary control, steering, or navigation systems
- Aviation, aerospace, nuclear, or critical defense systems

Unless explicitly agreed in writing under a formally executed agreement, Beetronics assumes no responsibility for such use. Where integrated into a regulated system, the system integrator is solely responsible for redundancy, monitoring, and system-level certification.

## 2.5 Environmental and Handling Precautions

### CAUTION

#### Operating Environment

- Install and operate the display within the specified environmental limits defined in this manual.
- Avoid prolonged exposure to direct sunlight or high-intensity light sources to prevent discoloration or degradation.
- Do not block ventilation openings.
- Ensure adequate airflow to prevent overheating.

### CAUTION

#### Condensation Risk

If the display is moved from a cold environment to a warmer environment, condensation may form on internal or external surfaces.

Do not power on the display until condensation has fully evaporated.

## 2.6 Accessories and Modifications

### CAUTION

#### Approved Accessories Only

Use only accessories, mounting hardware, and components specified or recommended by Beetronics.

Use of unapproved accessories may result in equipment damage or improper system integration.

#### Unauthorized Modifications

Any modification to the enclosure, electronic circuitry, firmware, or power delivery system constitutes a substantial modification.

Beetronics assumes no responsibility for the safety, performance, or compliance of products modified by third parties.

## 2.7 General Safety Instructions

### NOTICE

#### Professional Installation Required

Installation and integration must be performed by qualified personnel familiar with applicable standards and local regulations.

Read this manual carefully before installation or operation.

# 3

Mechanical Installation & Mounting

# 3. Mechanical Installation & Mounting

» This chapter defines the technical requirements for the physical integration of the display component. In accordance with the professional classification of this product, mechanical installation shall be performed by qualified personnel familiar with the requirements of the final application and installation environment.

## 3.1 Delivery Inspection and Package Contents

Upon receipt, inspect the shipping container for visible damage prior to opening.

Carefully unpack the display component and verify that all standard items shown in the package content overview are present and undamaged.

Retain the original packaging materials for potential transport, storage, or return service.

If damage, shortages, or discrepancies are identified, do not proceed with installation. Report the issue immediately to the carrier or the appropriate Beetrionics point of contact.

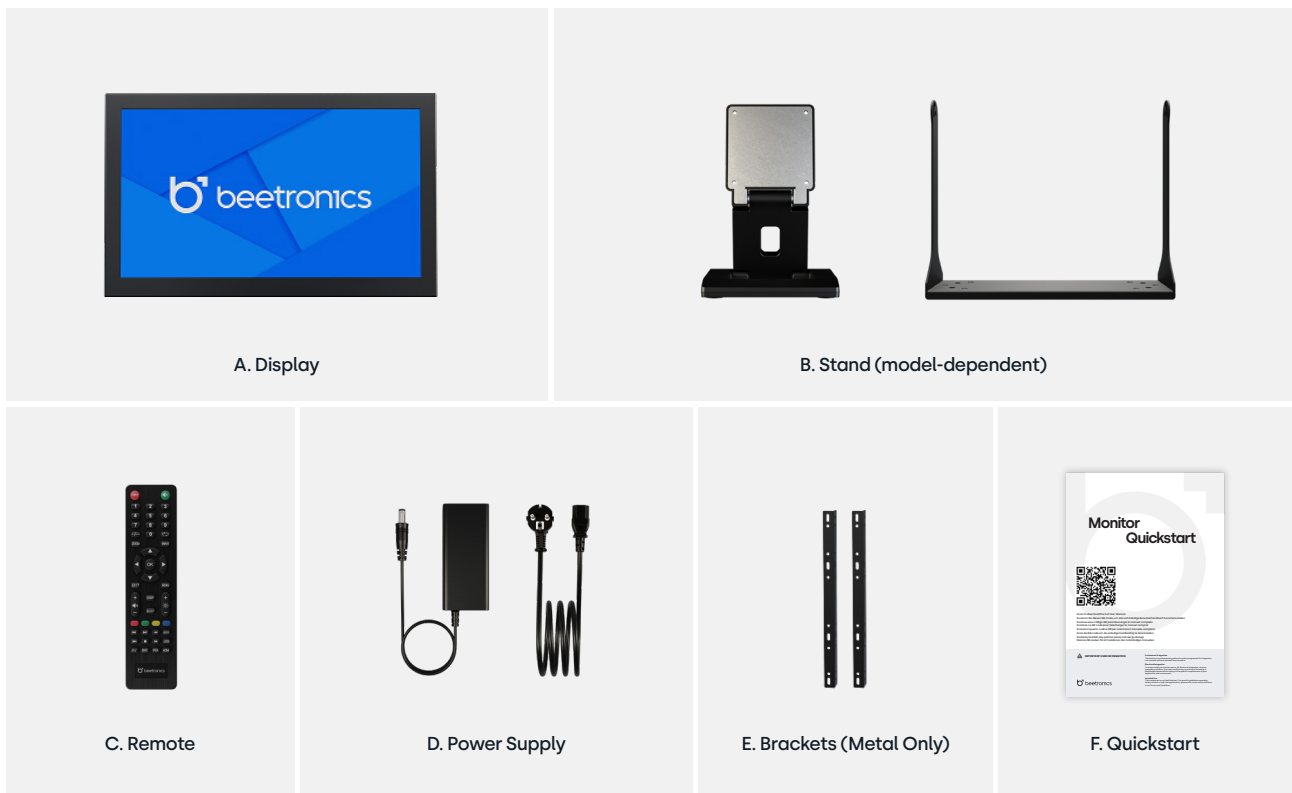

### 3.2 Installation Site Requirements

To ensure optimal performance, reliability, and product longevity, the installation site shall meet the following requirements.

- **Ventilation:** Do not obstruct ventilation openings. Restricted airflow may prevent proper cooling and result in overheating.
- **Thermal Limits:** Operate the display only within the specified temperature range of  $-10\text{ }^{\circ}\text{C}$  to  $+60\text{ }^{\circ}\text{C}$  ( $14\text{ }^{\circ}\text{F}$  to  $+140\text{ }^{\circ}\text{F}$ ).
- **Light Exposure:** Avoid prolonged installation in direct sunlight or near high-intensity heat sources. Excessive heat exposure may lead to discoloration, reduced performance, or internal damage.
- **Acclimatization:** If the display is moved from a cold environment to a warmer location, allow sufficient time for temperature stabilization. Do not apply power until any condensation has completely evaporated.

### 3.3 Mounting Methods

The display supports multiple professional mounting configurations depending on the model and enclosure type. All mounting hardware and installation methods must be properly rated and appropriate for the display's weight and the specific installation environment.

#### 3.3.1 Desktop Installation (Standard Configuration)

All Beetronics monitors are supplied with a desktop support system as standard. Depending on the selected model, this consists of:

- A foldable plastic stand, or
- A metal gimbal bracket assembly



#### Plastic Foldable Stand

The plastic stand is attached via the rear VESA interface (75 mm or 100 mm depending on model).

The hinge mechanism requires firm force to open. This resistance is intentional and designed to ensure mechanical stability and prevent unintended tilting.

Rubber pads are located on the underside of the stand. If permanent fixation is required, the rubber pads may be removed to access integrated mounting holes for surface fastening.



#### Metal Gimbal Bracket

The metal gimbal bracket consists of three connected steel plates forming a rigid support assembly. The bracket is mounted to the side mounting points of the display enclosure using the pre-installed screws.

The gimbal bracket is intended to be mechanically secured to the supporting surface. Operating the display without fastening the bracket assembly may result in instability or tipping.

For all desktop installations:

- The supporting surface shall be level and mechanically stable.
- The load capacity shall exceed the total weight of the display and mounting assembly.
- Adequate ventilation clearance shall be maintained.

### 3.3.2 VESA Mounting Interface

All displays are equipped with a standard VESA mounting pattern (75 mm or 100 mm, model dependent) located on the rear enclosure.

Use the four threaded mounting points to secure a compatible VESA mounting system to the display enclosure.

#### NOTICE

##### Fastener Selection

Use only mounting screws of the correct specification and length. Screws exceeding the allowable thread depth may cause internal damage to the display assembly.

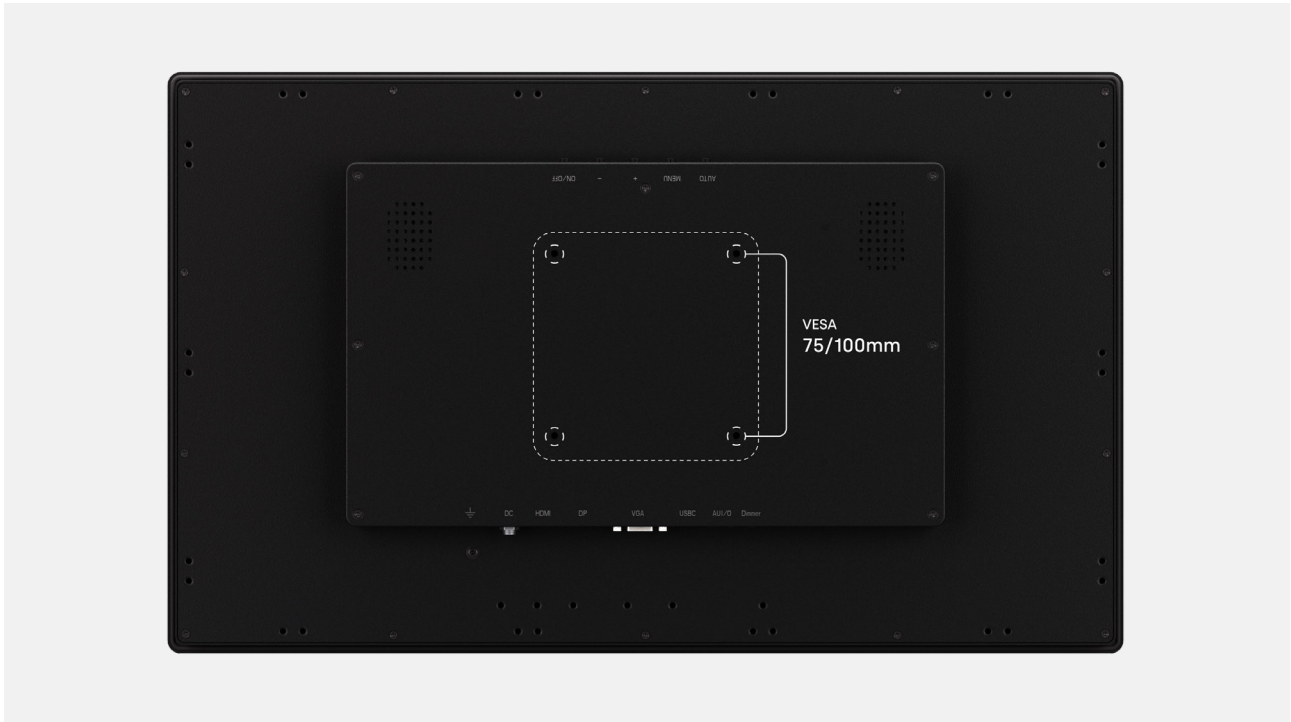

### 3.3.3 Wall Mounting (Optional VWB1 Bracket or Third-Party VESA Mount)

The display may be wall-mounted using:

- The optional VWB1 wall bracket, or
- A compatible third-party VESA mounting system

All installations must match the VESA pattern and support the full weight of the display.



#### VWB1 Wall Bracket Installation

The VWB1 bracket consists of two components:

1. A mounting plate that attaches to the rear VESA interface of the display.
2. A wall plate that mounts to the supporting structure.

Installation procedure:

1. Remove the existing stand assembly.
2. Secure the display mounting plate to the VESA interface.
3. Secure the wall plate to the wall using anchors appropriate for the wall material.
4. Attach and secure the display assembly to the wall-mounted plate.

The weight of the display must not exceed the rated load capacity of the bracket.

#### Third-Party VESA Mounts

The VESA interface may also be used with compatible mounting systems, including:

- Universal wall mounts
- Ceiling mounts
- Pole mounts
- Articulating arms

The system integrator is responsible for verifying mechanical compatibility and load capacity.

### 3.3.4 Flush Mounting (Metal Enclosure Models Only)

Flush mounting is supported exclusively on models with a metal enclosure. These models are supplied with L-shaped steel mounting brackets. The brackets may be installed in two configurations:

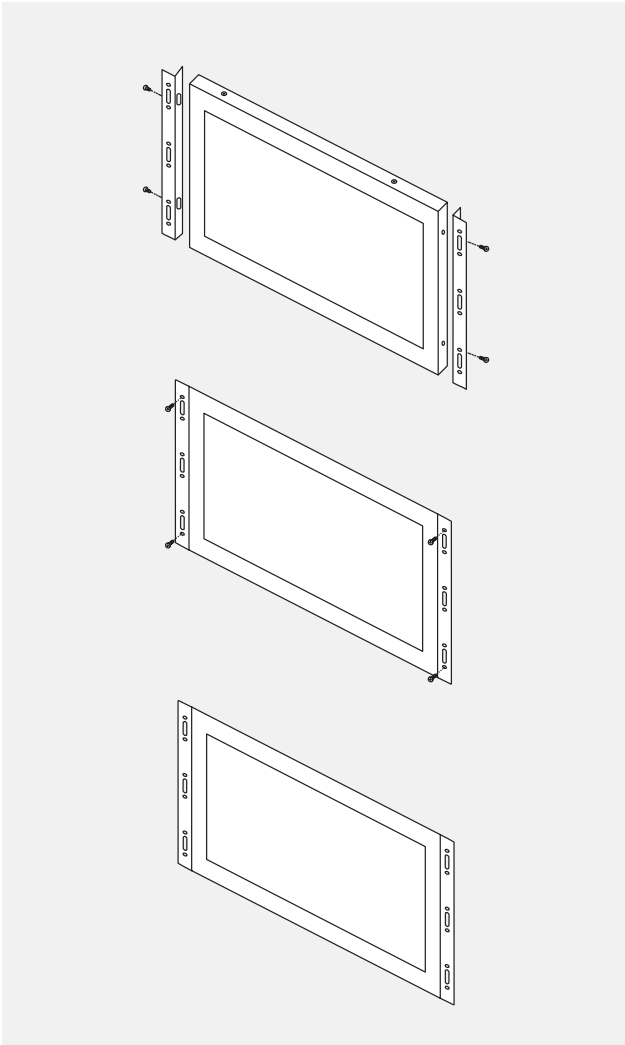

#### Configuration A | Surface-Fixed

The brackets are first attached to the display enclosure. The assembly is then secured directly to the mounting surface.

- Mounting screws remain visible from the front.
- Overall width increases slightly due to bracket thickness.

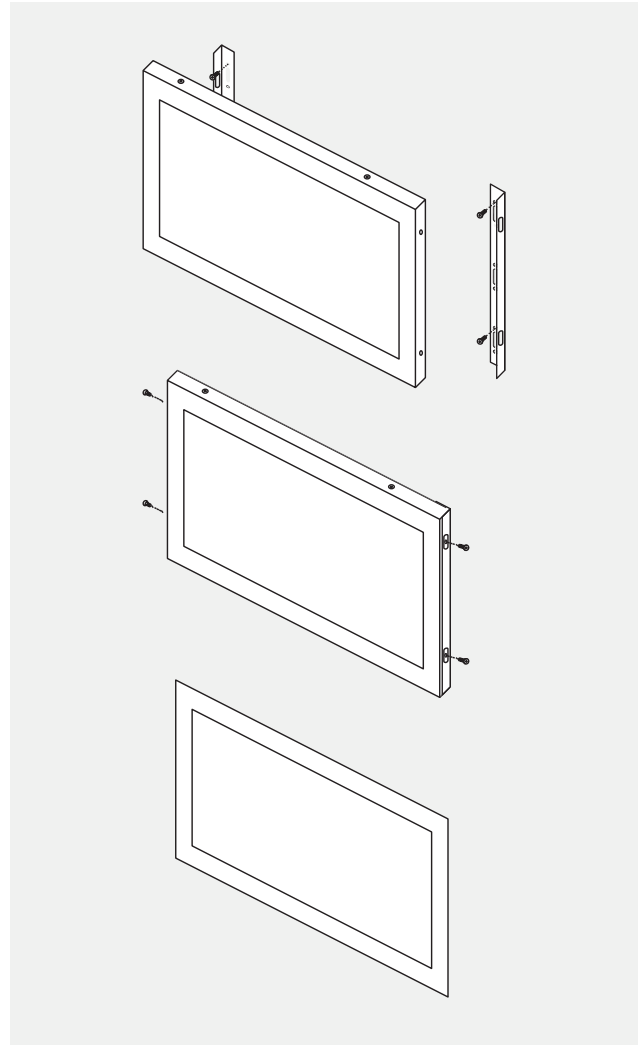

#### Configuration B | Recessed Installation

The brackets are first secured to the mounting surface. The display is then inserted and secured from the side.

- Front surface remains visually clean.
- Display width increases minimally due to bracket thickness.

#### Installation requirements:

- Mounting surface shall provide sufficient structural rigidity.
- Adequate ventilation clearance must be maintained.
- Only original enclosure mounting points shall be used.

Flush mounting is not supported on plastic enclosure models unless otherwise specified.



### 3.3.5 Rack Mounting (Optional RMK7 Rack Adapter Plate)

Selected models may be installed in a standard 19-inch equipment rack using the optional RMK7 rack adapter plate. The RMK7 consists of a fixed metal rack plate with integrated 19-inch rack mounting flanges. Multiple hole patterns support various VESA configurations.

The display is secured to the rack plate via the rear VESA interface. This is a fixed mounting solution. Sliding rails or drawer mechanisms are not included.



#### Compatibility

- Maximum horizontal installation width: 19-inch 5:4 display.
- 17-inch widescreen models are compatible.
- Smaller displays may be mounted; unused rack space may remain.
- Portrait configurations may be possible depending on rack design.
- Multiple smaller displays may be installed side-by-side where space permits.

#### Installation requirements:

- The combined weight shall not exceed rack load capacity.
- Adequate airflow shall be maintained within the rack enclosure.
- Rack fasteners shall match rack rail specifications.

### 3.4 Compass Safe Distance (Maritime Installations)

For maritime installations, the display shall be positioned to prevent magnetic interference with navigation equipment.

The values provided below support component-level evaluation in accordance with maritime standards including DNV-CG-0339 and IEC 60945.

 **WARNING**

#### Magnetic Interference

To ensure proper magnetic compass operation, the display must be installed at or beyond the minimum safe distance specified below.

The system integrator is responsible for verifying compass performance and ensuring final vessel-level compliance after installation.

Model	Max Value Standard Compass:	Max Value Steering Compass:
7VG7M	350mm	300mm
7HD7M	350mm	300mm
8VG7M	850mm	800mm
8HD7M	850mm	800mm
9HD7M	850mm	800mm
10VG7M	850mm	800mm
10HD7M	850mm	800mm
12VG7M	850mm	800mm
12HD7M	850mm	800mm
13HD7M	850mm	800mm
15HD7M	850mm	800mm
15VG7M	850mm	800mm
17VG7M	850mm	800mm
17HD7M	850mm	800mm
19VG7M	850mm	800mm
19HD7M	850mm	800mm
22HD7M	850mm	800mm
24HD7M	850mm	800mm
27HD7M	850mm	800mm



Electrical & System Integration

# 4. Electrical & System Integration

» This chapter defines the technical requirements for electrical power integration, grounding, and signal interfacing of the display component. Electrical integration shall be performed by qualified personnel in accordance with applicable safety standards and local regulations.

## 4.1 Power Supply Requirements

The display component has been evaluated at component level using approved Beetrionics power supplies.

 **WARNING**

### Power Supply Selection

Use only the official Beetrionics power supply supplied with the product or the model specified for the applicable region or configuration. Use of unauthorized adapters, modified power supplies, or third-party power sources may introduce safety risks and may result in operation outside the evaluated compliance configuration.

### Sector-Specific Power Configurations

The standard power supply provided with the display is intended for general professional use only. For installations requiring compliance with specific regulatory frameworks, the standard power supply must be replaced with the corresponding Beetrionics sector-specific power supply:

Maritime Applications (DNV / IEC 60945): Compliance requires the exclusive use of the PSU1-MAR power supply.

 **WARNING**

### Medical Use Limitation

The display is not a medical device and is not intended for use as a primary medical alarm or safety indicator. Audio or visual output functions shall not be relied upon for critical patient notification or life-sustaining functions.

## 4.2 DC Power Integration

The display hardware supports a DC input range of 9 V to 36 V to provide integration flexibility.

**NOTICE**

### Integration into External DC Systems

Direct connection to raw, unregulated, or transient-prone DC power sources (such as vehicle or industrial battery systems) is outside the scope of the evaluated compliance configuration.

Where integration into external DC systems is required, voltage stability, surge protection, transient suppression, filtering, and safety isolation shall be validated at the system level by the integrator.

## 4.3 Grounding and Isolation

Displays with metal enclosures are equipped with a grounding screw marked with the protective earth symbol .

 **WARNING**

### Earthing and Isolation

Determination and implementation of the appropriate grounding method is the responsibility of the system integrator or installer.

The final installation shall ensure:

- Proper protective earth connection where required
- Prevention of ground loops
- Compliance with applicable safety and EMC requirements
- Proper management of interaction between DC negative and chassis earth in isolated or floating systems

Failure to implement an appropriate grounding scheme may result in unsafe conditions or EMC non-compliance.

## 4.4 Signal Connections

To operate correctly, the display must be connected to a compatible video source and, where applicable audio input.

### Video Interfaces

- **HDMI**: transmits video and audio
- **VGA**: transmits video only
- **BNC (CVBS)**: transmits video only
- **RCA**: transmits video only

### Audio Integration

Where video-only interfaces are used, audio must be connected separately via the **AUX IN** port. External speakers or headphones may be connected to the **AUX OUT** port where supported.

**NOTICE**

### Audio Signal Routing

The AUX OUT port is designed for audio extraction from digital sources (HDMI). Analog audio received via the AUX IN port is intended for playback through the integrated speakers only and is not routed to the AUX OUT port.

**NOTICE**

### Signal Integrity and Cable Routing

To maintain signal integrity and EMC performance, do not exceed the following recommended maximum cable lengths:

- **HDMI**: 10 m
- **VGA**: 15 m
- **RCA**: 50 m
- **BNC**: 100 m
- **AUX**: 10 m

Signal and power cables shall be strain-relieved and routed to minimize electromagnetic interference and mechanical stress.

## 4.5 Initial Installation & Connection Overview

This section describes the recommended sequence for first-time power-up and functional verification of the display.

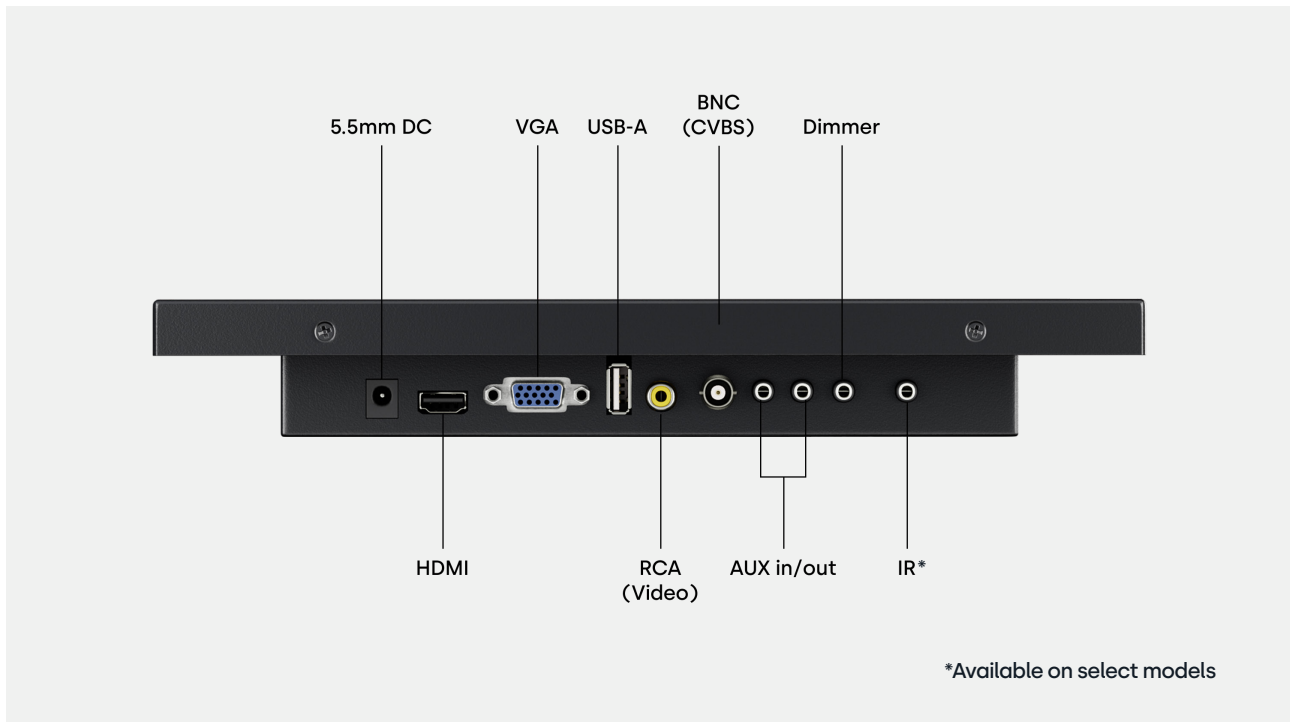

## 4.6 Foreseeable Misuse and Integration Risks

The display component is designed for professional integration. The following foreseeable integration errors or improper use scenarios may result in malfunction, reduced performance, equipment damage, or loss of compliance at the system level.

Improper integration may lead to unpredictable system behavior, reduced lifespan, EMC non-compliance, or permanent hardware damage. Beetronics assumes no responsibility for system-level failures resulting from improper integration practices.

### NOTICE

#### System-Level Integration Responsibility

The system integrator is responsible for preventing the following foreseeable misuse scenarios:

- **Unregulated Power:** Direct connection to raw or unregulated DC power systems (e.g., vehicle batteries) without appropriate stabilization, filtering, and transient protection, outside the evaluated DC 9–36 V range.
- **Cable Lengths:** Exceeding recommended maximum signal cable lengths for HDMI, VGA, RCA, BNC, or Aux connections.
- **Signal Quality:** Use of low-quality, unshielded, or improperly grounded signal cables.
- **Interference:** Routing signal cables parallel to high-current or high-frequency power lines without adequate separation.
- **Thermal Management:** Installation inside sealed enclosures without sufficient ventilation or thermal dissipation, leading to temperatures exceeding the +60 °C (140 °F) operating limit.
- **Moisture:** Powering the unit while condensation is present or operating outside the 10% – 90% non-condensing humidity range.
- **Unauthorized Power Supplies:** Use of non-approved or modified power supplies instead of the specified Beetronics power adapter or sector-specific PSUs (PSU1-MAR / PSU1-MED) where required for compliance.
- **Mechanical Stress:** Improper integration resulting in mechanical stress caused by incorrect mounting hardware (e.g., VESA 75x75 mm screws that are too long) or excessive fastener torque.



Operation & USB Media Playback

# 5. Operation & USB Media Playback

» This chapter describes normal operation of the display, including control interfaces, menu configuration, system behavior, and USB media playback functionality.













## 5.1 Remote Control

The display is operated using the supplied infrared remote control. The remote provides access to power control, input selection, OSD navigation, brightness adjustment, and USB playback functions.

For reliable operation, ensure direct alignment with the infrared receiver. On certain narrow bezel models, the receiver is positioned at the rear of the enclosure. Reduced responsiveness is typically caused by misalignment or depleted batteries.

The remote control is required to unlock Key Lock mode and to access advanced system configuration settings.



	<b>Power button</b>	Boot or enter standby state
	<b>Mute button</b>	Silence or restore audio output
1-0	<b>Digit keys (1-0)</b>	Used in menu and for numeric selection
	<b>Return button</b>	Return to previous menu or function
INPUT	<b>Input button</b>	Select the input source channel
	<b>Cursor keys</b>	Navigate up, down, left, and right
OK	<b>OK button</b>	Confirm your selection
EXIT	<b>Exit button</b>	Exit menu or current operation
MENU	<b>Menu button</b>	Open or close the OSD menu
DISP	<b>Disp button</b>	Display current source information
	<b>Volume (+ / -)</b>	Increase or decrease audio volume
	<b>Brightness (+ / -)</b>	Adjust the backlight intensity
SLEEP	<b>Sleep button</b>	Set the automatic sleep timer
	<b>Previous</b>	Skip to the previous file (USB media files)
	<b>Play/Pause</b>	Play or pause playback (USB media files)
	<b>Rewind</b>	Rewind playback (USB media files)
	<b>Next</b>	Skip to the next file (USB media files)
	<b>Stop</b>	Stop playback (USB media files)
	<b>Fast Forward</b>	Fast forward playback (USB media files)

## 5.2 Physical Control Buttons

The display enclosure includes integrated control buttons for local operation. Button layout varies between metal and plastic enclosure models, but functionality remains consistent.

The enclosure controls allow power operation, input selection, menu access, and parameter adjustment. These controls provide basic configuration capability without requiring the remote control.

If Key Lock is enabled, the enclosure buttons are disabled and configuration must be performed using the remote control.

### Metal Monitor

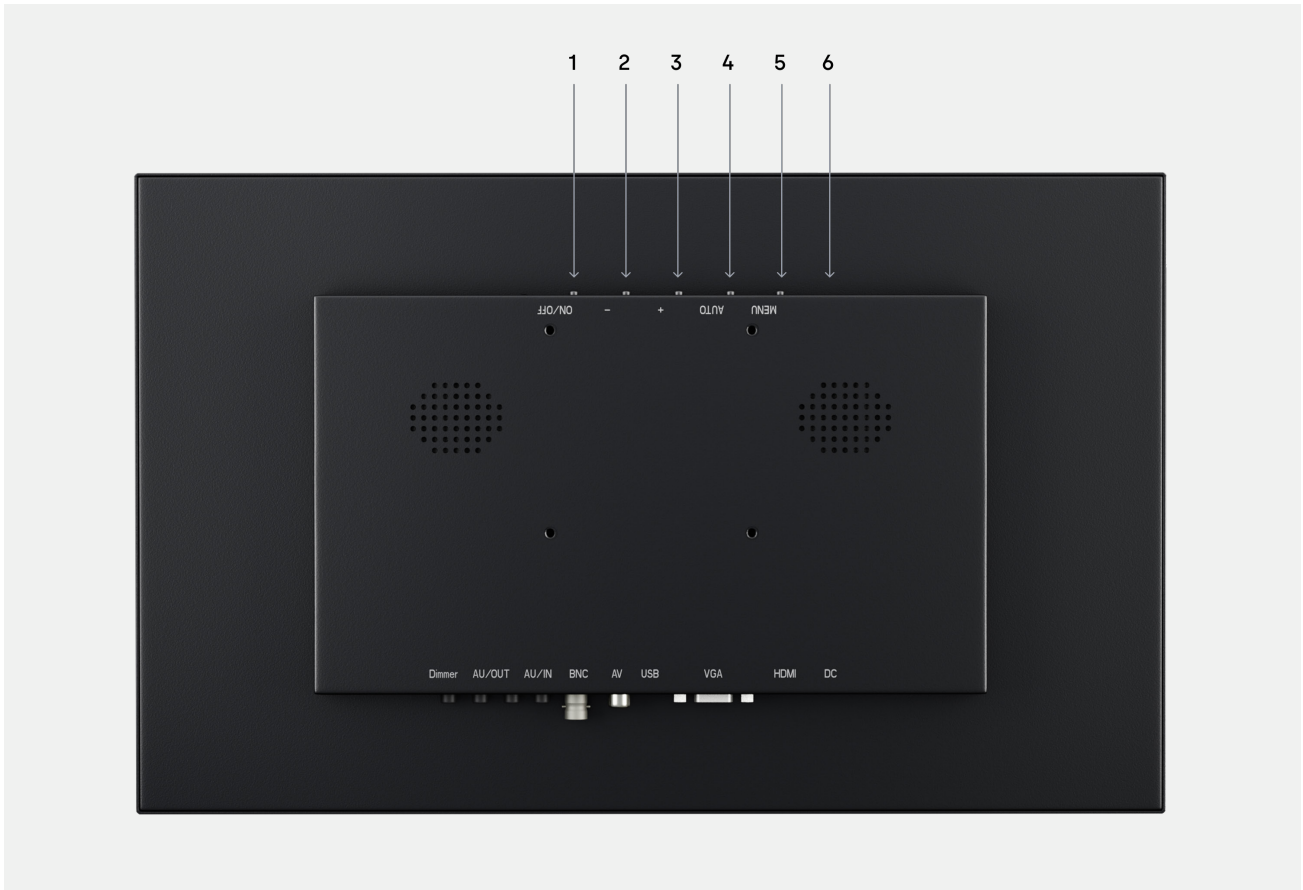

- |   |               |  |
|---|---------------|--|
| 1 | <b>ON/OFF</b> | • Power On/Off   |
| 2 | <b>—</b>      | • Decrease value   |
| 3 | <b>+</b>      | • Increase value   |
| 4 | <b>AUTO</b>   | • Select source<br>• Cycle options<br>• In-menu selector |
| 5 | <b>MENU</b>   | • Open menu<br>• In-menu back                            |
| 6 | <b>LED</b>    | • Power on: green light<br>• Standby: red light          |



## Plastic Monitor



- |          |              |   |
|----------|--------------|---|
| <b>1</b> | <b>POWER</b> | <ul style="list-style-type: none"><li>• Power On/Off</li></ul>  |
| <b>2</b> | <b>MENU</b>  | <ul style="list-style-type: none"><li>• Open menu</li><li>• In-menu back</li></ul>                                      |
| <b>3</b> | <b>+</b>     | <ul style="list-style-type: none"><li>• Right</li><li>• Increase Value</li><li>• In-menu- select</li></ul>              |
| <b>4</b> | <b>-</b>     | <ul style="list-style-type: none"><li>• Left</li><li>• Decrease value</li></ul>   |
| <b>5</b> | <b>AUTO</b>  | <ul style="list-style-type: none"><li>• Select source</li><li>• Cycle options (up/down)</li><li>• Menu select</li></ul> |

### 5.3 OSD Menu

Press the MENU button on the remote control or on the display enclosure to access the On-Screen Display (OSD).

Menu navigation is performed using the cursor keys on the remote control or the directional buttons on the enclosure. Confirm selections using the OK (ENTER) button on the remote or the corresponding selection button on the display.

The OSD is organized into four primary categories, each represented by a separate tab:



- 1     **PICTURE**
- 2     **SOUND**
- 3     **TIMER**
- 4     **GENERAL**

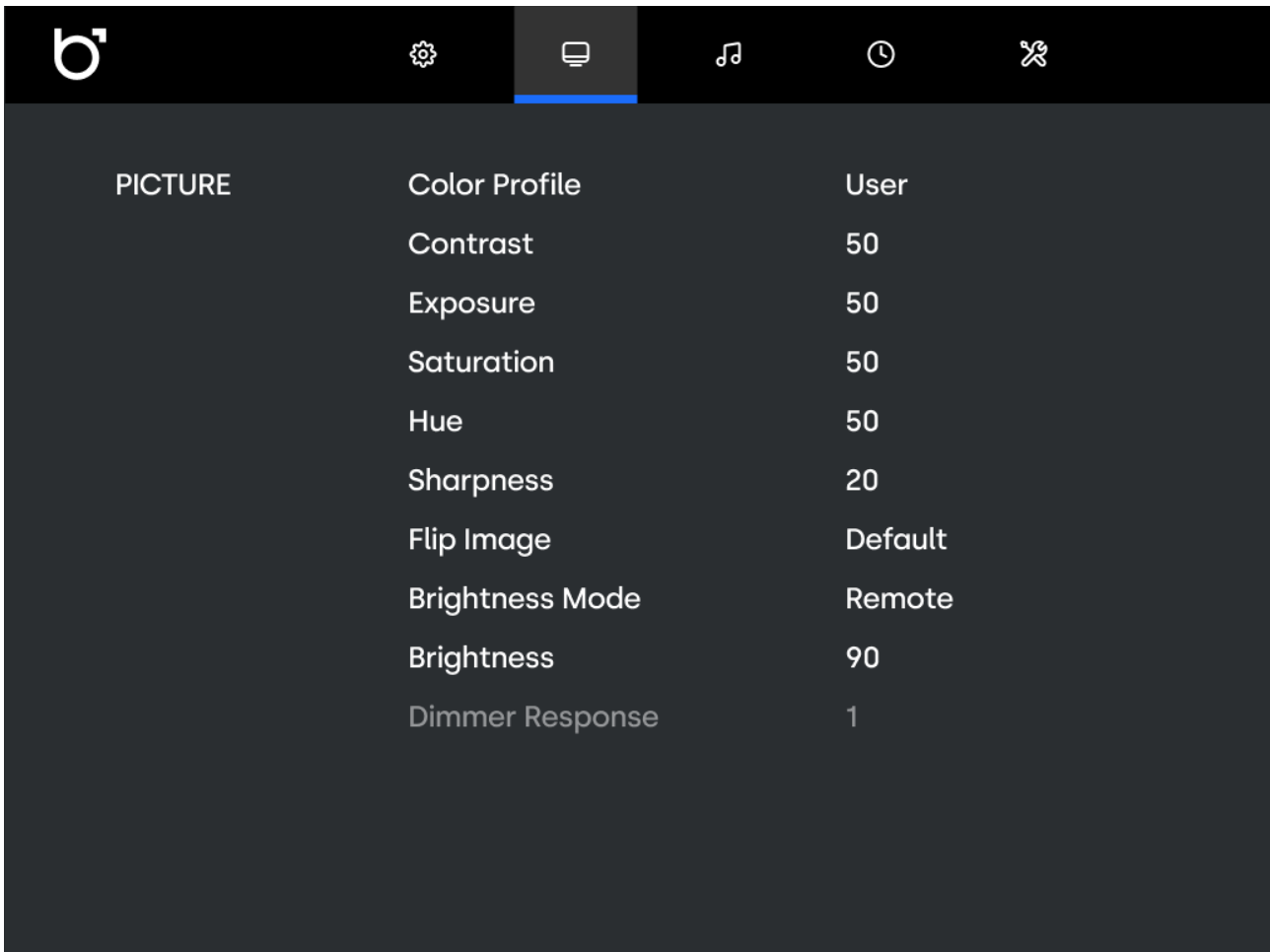

### 5.3.1 Picture

#### Color Profile

Select a predefined picture preset. Select the "User" preset to manually adjust contrast, brightness, color, and sharpness.

#### Contrast

Adjust the difference between the lightest and darkest areas of the image. This parameter is only adjustable when Picture Mode is set to "User".

#### Exposure

Adjust the overall image luminance. This parameter is only adjustable when Picture Mode is set to "User".

#### Saturation

Adjust the color saturation levels. This parameter is only adjustable when Picture Mode is set to "User".

#### Hue

Adjust the color balance between red and green tones. This parameter is only adjustable when Picture Mode is set to "User".

#### Sharpness

Adjust the edge definition of the image for a sharper or softer appearance. This parameter is only adjustable when Picture Mode is set to "User".

#### Flip Image

Select the preferred image orientation. Available options: Default (Normal), Horizontal, Vertical, and Horizontal + Vertical.

#### Brightness Mode

Selects how the display brightness is controlled. Available options include remote or dimmer (potentiometer)

#### Brightness

Manually adjust the LED backlight intensity from 1–100.

#### Dimmer Response

Controls how quickly the brightness changes when using an external dimmer. Lower values provide finer control, while higher values result in larger adjustment steps.

If flickering occurs, reduce the setting to improve stability.

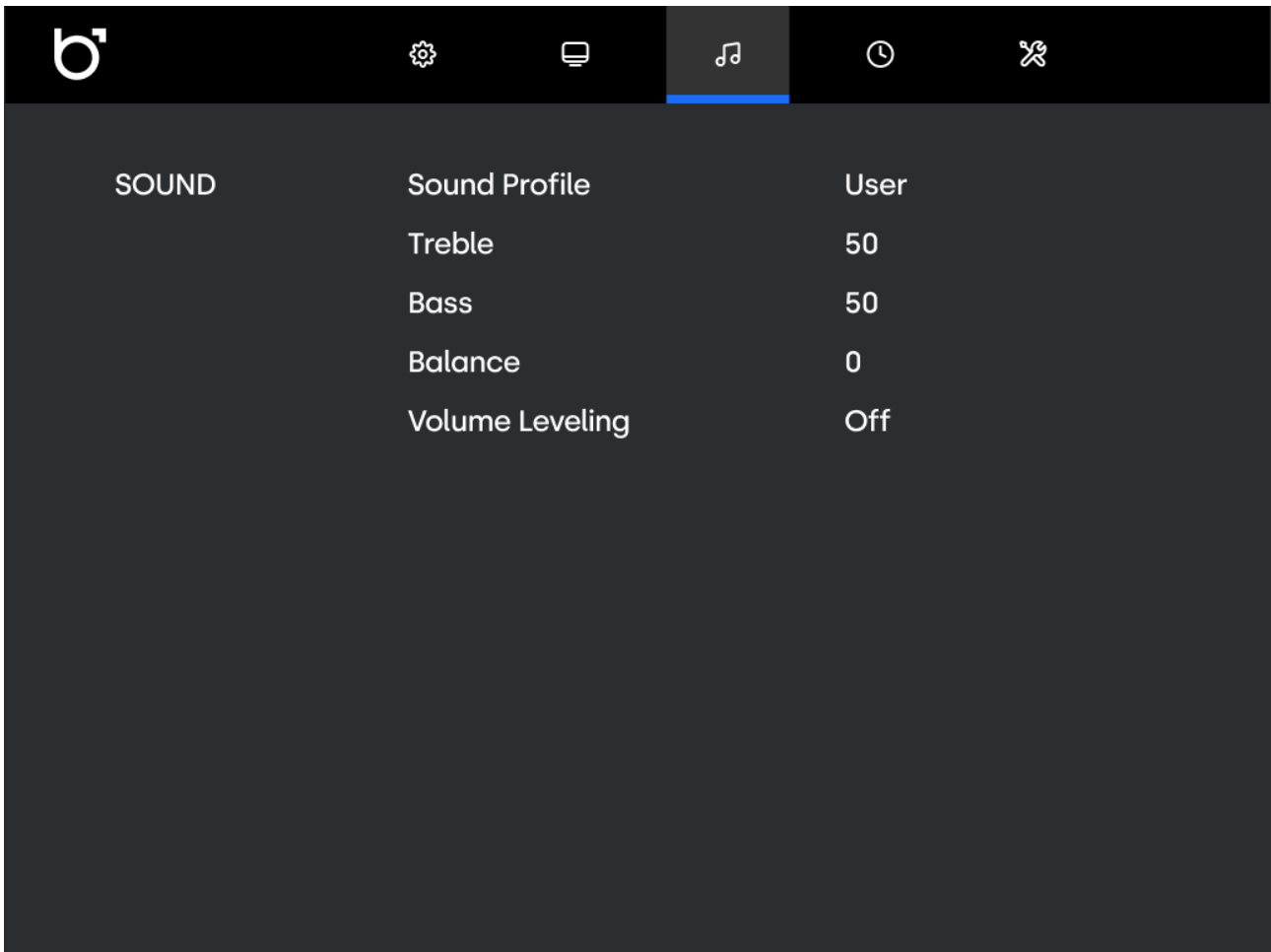

### 5.3.2 Sound

#### Sound Profile

Select a predefined audio preset. Select the "User" preset to manually adjust treble and bass.

#### Treble

Adjust the intensity of high-frequency audio. This parameter is only adjustable when Sound Mode is set to "User".

#### Bass

Adjust the intensity of low-frequency audio. This parameter is only adjustable when Sound Mode is set to "User".

#### Balance

Adjust the relative volume balance between the left and right audio channels.

#### Volume Leveling

Enable automatic volume leveling to minimize sudden changes in loudness when switching between inputs or content.

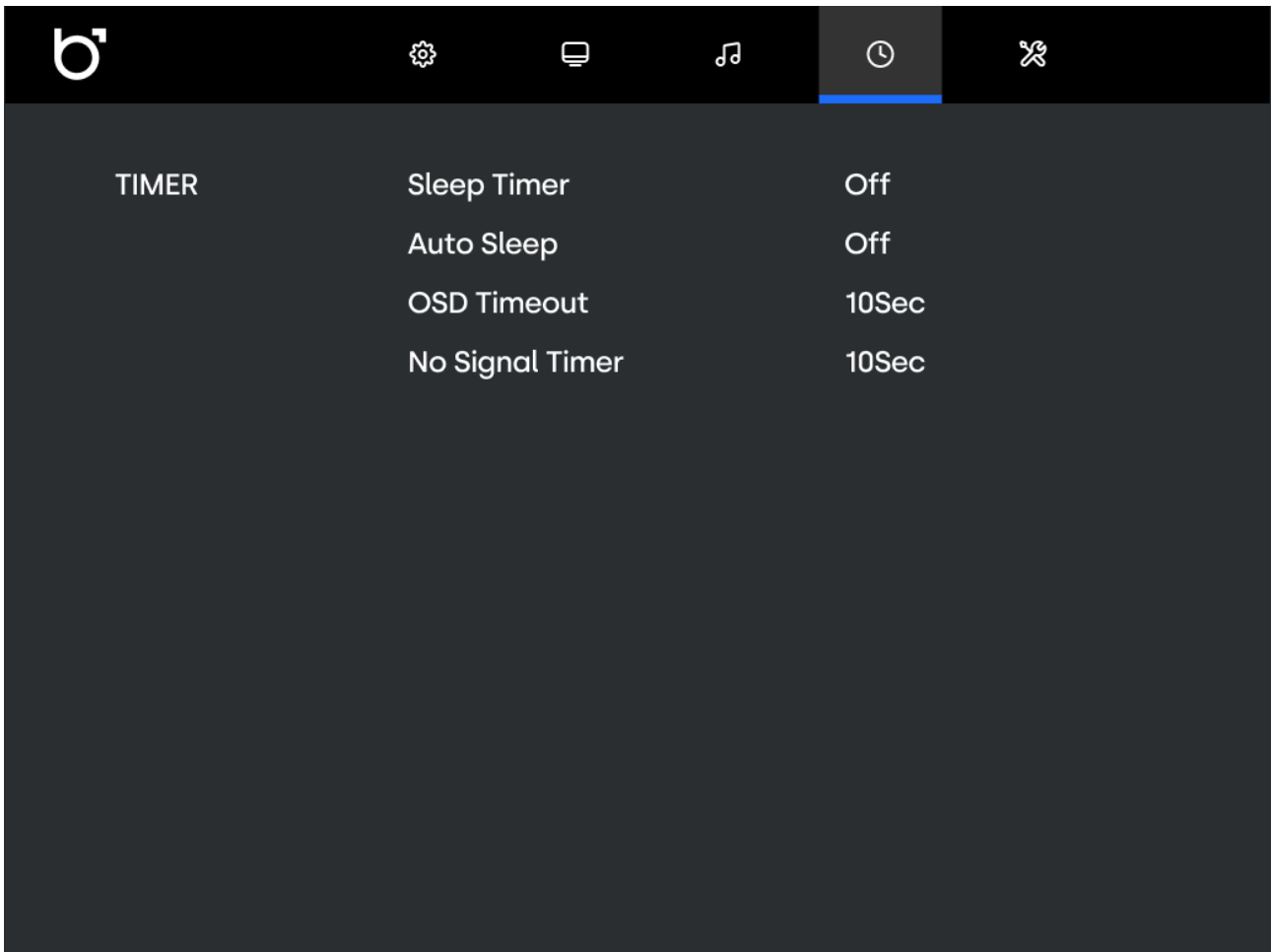

### 5.3.3 Timer

#### Sleep Timer

Set a predetermined time interval after which the display will automatically switch to standby mode.

#### Auto Sleep

Set the display to automatically enter standby mode when no user interaction is detected for a specified period.

#### OSD Timeout

Adjust the amount of time the On-Screen Display (OSD) menu remains active on the screen before automatically closing.

#### No Signal Timer

Define the duration the display stays powered on while no active video signal is detected before entering standby mode.

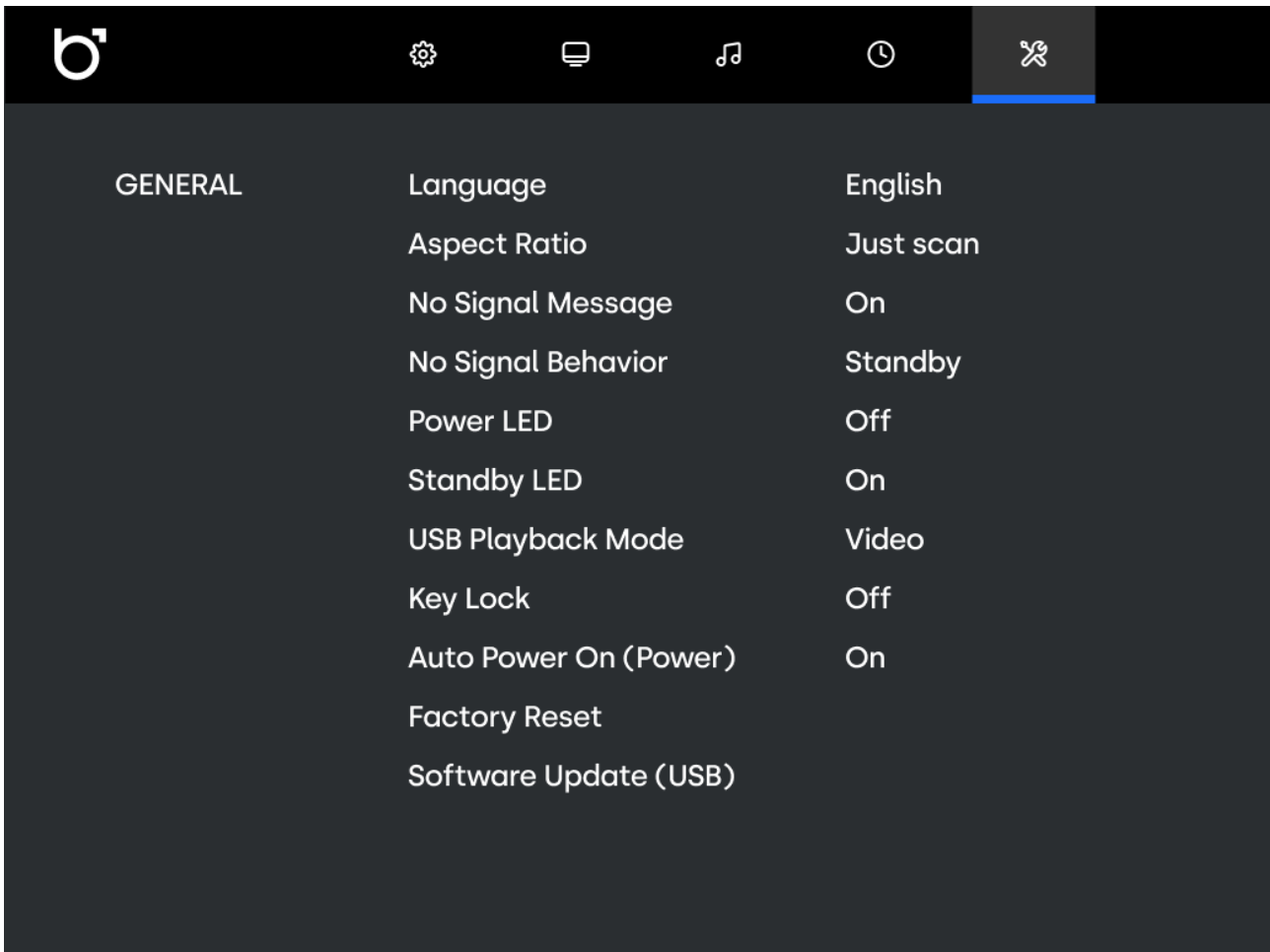

### 5.3.4 General

#### Language

Select the preferred language for the On-Screen Display (OSD) menu.

#### Aspect Ratio

Adjust the display format to match the input source. Options include 16:9, 4:3, and Just Scan.

#### No Signal Message

Defines whether the "No Signal" message is displayed when no active input signal is detected.

#### No Signal Behavior

Define the power behavior when no signal is present, such as automatically entering standby mode.

#### Power LED

Enable or disable the green status indicator LED on the display enclosure.

#### Standby LED

Enable or disable the red standby indicator LED on the display enclosure.

#### USB Playback Mode

Automatically initiate playback of supported media files from a connected USB storage device.

#### Key Lock

Disable the physical control buttons on the display enclosure to prevent unauthorized adjustments. The remote control is required to disable this function.

#### Auto Power On (Power)

Configure the display to automatically power on as soon as DC power is applied.

#### Factory Reset

Restore all OSD menu settings and picture adjustments to the original factory default values.

#### Software Update (USB)

Perform a system firmware update using a compatible USB storage device containing authorized software files.

## 5.4 USB Media Playback

Certain models within the Monitor Series include integrated USB media playback functionality. This feature enables direct playback of supported media files from a USB storage device.

### USB Device Requirements

The USB storage device shall comply with the following specifications:

- File system: FAT32
- Maximum supported capacity: 32 GB
- Only supported media file formats are recognized by the internal player.

Use of unsupported file systems, excessive storage capacity, or incompatible file formats may prevent recognition or playback.

### USB Input Selection

USB playback functions as a dedicated input channel. After inserting a USB storage device, the USB input must be selected using the remote control or control buttons on the display. Media files available on the device can then be selected for playback.

### Autoplay on Power Restoration

If a media file is actively playing and the power supply is interrupted, playback will automatically resume upon restoration of power when the Auto Power On and Autoplay on Current functions are enabled.

### Playback Transition Behavior

When multiple separate media files are played sequentially, a brief black transition screen may appear between files. This behavior is inherent to the internal playback process.

For uninterrupted continuous playback without visible transition, a single extended media file shall be used instead of multiple separate files.

## Supported USB Media Player File Formats

Type	Suffix	Video Coding Format	Audio Coding Format	Specifications
Movie	AVI	AVC MPEG MPEG-4 MPEG-4DivX5 MPEG-4Xvid	MP3	Rate: 1080@30fps MaxData Rate: 20Mbps
	MP4	AVC MPEG-4	AACLC AACLC, SBR, MPEG	Rate:1080@30fps MaxData Rate: 20Mbps
	MOV	AVC MPEG-4	AACLC,	Rate:1080@30fps MaxData Rate: 20Mbps
	MPG	MPEG	MPEG PCM	Rate:1080@30fps MaxData Rate: 20Mbps
	WMV	VC-1 WMV3	WMA	Rate:1080@30fps MaxData Rate: 20Mbps
	VOB	MPEG COMPONENT MPEG NTSC MPEG VERSION	MPEG	Rate:1080@30fps MaxData Rate: 20Mbps
	RMVB	RealVideo 4	AACLC, AACLC, SBR, COOKER	Rate:1080@30fps MaxData Rate: 20Mbps
	MKV	AVC	AACLC	Rate:1080@30fps MaxData Rate: 20Mbps
	TS	AVC MPEG	MPEG	Rate:1080@30fps MaxData Rate: 20Mbps
	MPEG	MPEG	MPEG	Rate:1080@30fps MaxData Rate: 20Mbps
DAT	MPEG	MPEG	Rate:1080@30fps MaxData Rate: 20Mbps	

Type	Suffix	Video Coding Format	Audio Coding Format	Specifications
Photo	JPG	Progressive JPEG		MaxResolution: 1024x768
	JPEG	Baseline JPEG		MaxResolution: 15360x8640
	BMP	----		MaxResolution: 9600x6400 Pixel Depth: 1/4/8/4/32 bpp
	PNG	Non-Interlaced Interlaced		MaxResolution: 9600x6400 MaxResolution: 1200x800





Maintenance, Cleaning & Burn-in Prevention

# 6. Maintenance, Cleaning & Burn-in Prevention

» This chapter defines the required maintenance procedures, handling precautions, and operating practices to ensure continued reliability and visual performance of the display component. All maintenance and cleaning activities shall be performed with the power supply disconnected.

## 6.1 Maintenance and Handling Guidelines

To maintain optimal performance and prevent damage, the following handling precautions shall be observed.

### NOTICE

#### LCD Panel Handling

- Do not apply pressure to the LCD panel surface or the edges of the frame. Continuous or uneven pressure may result in liquid crystal degradation, interference patterns, or permanent display malfunctions.
- Do not scratch or press the LCD panel with sharp or hard objects.
- Do not clean or wipe the LCD surface with tissues or abrasive materials, as these may scratch or damage the panel coating.

## 6.2 Cleaning Instructions

Follow the procedure below when cleaning the display enclosure or LCD panel surface.

### Disconnect Power

Always disconnect the power supply before cleaning the unit.

### Cloth Selection

Use a clean, soft cloth lightly dampened with water or a professional screen-cleaning solution suitable for LCD panels, and gently wipe the display.

### Drying

Ensure that all surfaces are completely dry before reconnecting input cables and restoring power. No moisture shall be visible on the product surfaces.

### NOTICE

#### Prohibited Cleaning Agents

Do not use chemicals or cleaning agents that may damage the enclosure or LCD panel surface, including but not limited to:

- Alcohol or antiseptic solutions
- Thinner, benzine, or wax
- Abrasive cleaners, ammonia, or acetone

Use of these substances may result in surface degradation, discoloration, or permanent image quality deterioration.

## 6.3 Image Retention (Burn-In) Prevention

Prolonged display of static or unchanging images may cause image retention, also referred to as burn-in, after-imaging, or ghost imaging. This is a known characteristic of LCD panel technology.

### ⚠ WARNING

#### Permanent Image Damage

Failure to activate a moving screen saver or periodic screen refresh when displaying static content may result in severe image retention.

To reduce the risk of permanent image damage:

- Always activate a moving screen saver when the display is unattended
- Use periodic screen refresh or content rotation for static visual content

In severe cases, image retention effects may become permanent and cannot be corrected.

## 6.4 Environmental Operating Limits

To maintain performance and maximize product lifespan, the display shall be stored and operated within the following environmental limits.

- Operating Temperature: -10 °C to +60 °C (14 °F to +140 °F)
- Storage Temperature: -20 °C to +70 °C (-4 °F to +158 °F)
- Operating Humidity: 10 % to 90 % non-condensing



Troubleshooting & FAQ

# 7. Troubleshooting & FAQ

» This chapter provides troubleshooting guidance for common technical issues and answers to frequently asked questions related to the operation and integration of the display component. Only issues relevant to the display itself are included. Touchscreen issues, if present on other manual versions, are excluded from this chapter. Troubleshooting is intended to assist qualified integrators and installers. If an issue cannot be resolved using the guidance below, please contact your local Beetrionics support.

## 7.1 Troubleshooting

### Power & Startup

Issue	Possible Cause	Corrective Action
<b>Display does not power on</b>	<ol style="list-style-type: none"> <li>1. Power supply not connected or defective</li> <li>2. Incorrect DC voltage or polarity</li> </ol>	<ol style="list-style-type: none"> <li>1. Verify approved power supply connection and test with known functional unit</li> <li>2. Verify input voltage and polarity (9–36 V where applicable)</li> </ol>
<b>Power LED on, no image</b>	<ol style="list-style-type: none"> <li>1. No active video signal</li> <li>2. Incorrect input selected</li> </ol>	<ol style="list-style-type: none"> <li>1. Verify source device is powered and transmitting signal</li> <li>2. Select correct input via front panel or remote</li> </ol>

### Video Signal & Image Integrity

Issue	Possible Cause	Corrective Action
<b>"No Signal" message</b>	<ol style="list-style-type: none"> <li>1. Source not transmitting</li> <li>2. Unsupported timing</li> <li>3. Signal interruption via adapters/converters</li> </ol>	<ol style="list-style-type: none"> <li>1. Verify source output</li> <li>2. Set source to supported resolution and refresh rate</li> <li>3. Connect source directly to display to eliminate intermediate devices</li> </ol>
<b>Image blurry or soft</b>	<ol style="list-style-type: none"> <li>1. Resolution mismatch</li> <li>2. Excessive cable length or signal attenuation</li> </ol>	<ol style="list-style-type: none"> <li>1. Configure source to native resolution</li> <li>2. Do not exceed recommended maximum cable lengths.</li> </ol>
<b>Image flickers or unstable</b>	<ol style="list-style-type: none"> <li>1. Electrical interference</li> </ol>	<ol style="list-style-type: none"> <li>1. Separate signal and power cables; eliminate nearby interference sources</li> </ol>

<b>Vertical or horizontal line permanently visible</b>	1. Panel defect (if present on all inputs)	1. Verify across multiple inputs; if persistent, contact service support
<b>Circular spots, stains, or irregular patches</b>	1. Internal condensation behind panel	1. Power off and allow unit to stabilize in dry environment before reapplying power.

### OSD & Controls

<b>Issue</b>	<b>Possible Cause</b>	<b>Corrective Action</b>
<b>Remote control not responding</b>	<ol style="list-style-type: none"> <li>1. Weak IR signal alignment</li> <li>2. IR receiver location not visible (rear placement on narrow bezel models)</li> <li>3. Battery depleted</li> </ol>	<ol style="list-style-type: none"> <li>1. Aim remote directly at IR receiver; maintain close range</li> <li>2. Ensure line-of-sight to IR receiver; verify position in product overview</li> <li>3. Replace remote batteries</li> </ol>
<b>OSD menu inaccessible</b>	1. OSD menu inaccessible	1. Disable OSD key lock function

### USB Media Playback (If Applicable)

<b>Issue</b>	<b>Possible Cause</b>	<b>Corrective Action</b>
<b>USB device not recognized</b>	<ol style="list-style-type: none"> <li>1. Incorrect file system</li> <li>2. USB capacity exceeds supported limit</li> <li>3. Unsupported media format</li> </ol>	<ol style="list-style-type: none"> <li>1. Format USB device as FAT32</li> <li>2. Use USB device ≤ 32 GB</li> <li>3. Verify file format compatibility</li> </ol>

## 7.2 Frequently Asked Questions (FAQ)

### How is the display resolution configured?

Resolution and refresh rate are defined by the connected source device. The display does not generate output resolution. For optimal image clarity, configure the source to the native panel resolution supported by the display. Unsupported resolution or refresh rate settings may result in scaling artifacts or reduced sharpness.

### Why does the display show "No Signal"?

The "No Signal" message indicates that no valid video signal is detected on the selected input. Ensure that the correct input channel is selected and that the connected source device is transmitting an active signal. The output resolution and refresh rate must be supported by the display. If adapters, converters, splitters, or extension devices are used, remove them temporarily and connect the display directly to the source device to isolate any compatibility issues.

### How can panel defects be distinguished from signal-related artifacts?

Open the on-screen display (OSD) menu. If an artifact such as a vertical or horizontal line is visible within the OSD interface, the cause is internal to the display. If the artifact is not visible in the OSD, the issue originates from the external signal path, including the source device or signal cable.

### Why are vertical or horizontal lines permanently visible?

Lines that remain visible across all inputs and within the OSD interface typically indicate panel failure. Lines that appear only with a specific source are generally caused by signal configuration or source output issues.

### Why does the image appear blurry or improperly scaled?

Image sharpness depends on the resolution provided by the source device. If the source resolution does not match the native panel resolution, scaling is applied and image clarity may be reduced. Verify that the correct resolution and aspect ratio are configured at the source.

### Why does brightness control or dimming not function?

Brightness can be adjusted using the dedicated brightness buttons on the remote control or, where applicable, via the optional external dimmer (potentiometer). Within the OSD menu, the Backlight setting must correspond to the selected dimming method. If the configured dimming mode does not match the active control method, brightness adjustment will not function. Verify that the correct dimming method is selected in the OSD and that the control device is properly connected.

### Why does the remote control have limited responsiveness?

On certain models, the infrared receiver is positioned at the rear of the enclosure to preserve symmetrical bezel design. Ensure direct alignment with the receiver and operate the remote within close range. Verify that the batteries are functioning properly.

### The desktop stand requires significant force to open. Is this normal?

The hinge mechanism of the foldable plastic stand is intentionally designed with high resistance to ensure mechanical stability. Increased opening resistance is normal and does not indicate a defect.

### Why can image retention occur during static operation?

Image retention may occur when static content is displayed for extended periods. This is a known characteristic of LCD panel technology. Preventive measures are described in Chapter 6 | Maintenance, Cleaning & Burn-In Prevention.



Regulatory Notices

# 8. Regulatory Notices

» This chapter summarizes the regulatory framework and compliance scope applicable to the display component. It provides an overview of component-level regulatory evaluations. For complete and legally binding regulatory declarations, refer to Appendix A | Public Compliance Statement.

## 8.1 FCC Compliance (United States)

This device complies with Part 15 of the FCC Rules. Operation is subject to the following two conditions: (1) This device may not cause harmful interference, and (2) this device must accept any interference received, including interference that may cause undesired operation.

This equipment has been tested and found to comply with the limits for a Class B digital device, pursuant to Part 15 of the FCC Rules. These limits are designed to provide reasonable protection against harmful interference in a residential installation. This equipment generates, uses and can radiate radio frequency energy and, if not installed and used in accordance with the instructions, may cause harmful interference to radio communications.

However, there is no guarantee that interference will not occur in a particular installation. If this equipment does cause harmful interference to radio or television reception, which can be determined by turning the equipment off and on, the user is encouraged to try to correct the interference by one or more of the following measures:

- Reorient or relocate the receiving antenna.
- Increase the separation between the equipment and receiver.
- Connect the equipment into an outlet on a circuit different from that to which the receiver is connected.
- Consult the dealer or an experienced radio/TV technician for help.

### WARNING

#### Unauthorized Modifications

Changes or modifications not expressly approved by Beetrionics could void the user's authority to operate the equipment and invalidate the evaluated compliance configuration.

## 8.2 ISED Compliance (Canada)

This Class B digital apparatus complies with Canadian ICES-003. Cet appareil numérique de la classe B est conforme à la norme NMB-003 du Canada.

Operation is subject to the following two conditions:

1. This device may not cause interference, and
2. This device must accept any interference, including interference that may cause undesired operation of the device.

L'exploitation est autorisée aux deux conditions suivantes :

1. L'appareil ne doit pas produire de brouillage;
2. L'appareil doit accepter tout brouillage radioélectrique subi, même si le brouillage est susceptible d'en compromettre le fonctionnement.

## 8.3 Regional Compliance Scope

The display component is evaluated at component level against applicable regional regulatory frameworks where relevant. Regulatory compliance applies only to the product configuration as delivered and documented.

Sector-specific certifications or approvals, including maritime, railway, automotive, or medical standards, are configuration-dependent and may apply only to specific models, hardware revisions, and approved Beetrionics power supplies. Compliance is not universal across the Monitor Series and may depend on the exact SKU, hardware revision, power supply, and installation configuration.

Compliance is maintained only when the display is used with approved Beetrionics power supplies, installed in accordance with this manual, and not modified from the evaluated configuration.

For the precise certification status of a specific model and configuration, refer to Appendix A | Public Compliance Statement. Use of the display outside the evaluated configuration falls outside the documented compliance scope.

All applicable regulatory conformity markings are affixed to the product label in accordance with the specific model, configuration, and intended market.

## 8.4 System-Level Regulatory Responsibility

The display is supplied as an unintegrated component. Regulatory approval, certification, and conformity of the final integrated system remain the responsibility of the system integrator, OEM, or end manufacturer.

This includes, but is not limited to:

- Final EMC testing of the complete system
- Electrical safety certification of the assembled installation
- Environmental and sector-specific declarations
- Verification of compliance within the intended operational environment

Use of the display outside the evaluated component configuration falls outside the scope of Beetrionics' component-level assessments.

## 8.5 Regulatory Contact Information

For regulatory documentation and component-level compliance inquiries, contact the appropriate Beetrionics entity:

European Union & Global  
Beetrionics B.V.  
Amsterdam, The Netherlands

United States & Canada  
Beetrionics Inc.  
Claymont, Delaware





Warranty & Contact Information

# 9. Warranty & Contact Information

» This chapter defines the limited warranty coverage, liability framework, and official contact channels applicable to the display component. All sales are subject to the applicable Beetrronics General Terms and Conditions.

## 9.1 Limited Warranty

Warranty coverage is provided by the contracting seller entity identified on the purchase invoice and is governed by the applicable Beetrronics Terms and Conditions referenced at the time of purchase.

Unless otherwise specified in the applicable Terms and Conditions, display components are covered for a period of two (2) years from the original date of purchase as evidenced by the purchase invoice.

### Warranty Coverage

The limited warranty applies to defects in materials and workmanship under normal and recommended operating conditions as defined in this manual and subject to the applicable Terms and Conditions.

### Remedy

In the event of a valid warranty claim, the contracting seller entity will, at its discretion and in accordance with the applicable Terms and Conditions, repair the defective unit or replace it with a functionally equivalent product. Warranty service may require proof of purchase.

## 9.2 Warranty Exclusions

The limited warranty does not apply to defects or damage resulting from causes outside the intended use and evaluated configuration of the product. Exclusions include, but are not limited to:

- **Unauthorized Modifications:** Any repair, disassembly, or modification performed by an unauthorized person or third party.
- **Improper Integration:** Damage caused by incorrect installation or integration into a system.
- **Environmental Limits:** Use outside the environmental limits defined in Section 6.4 (e.g., moisture, excessive heat, or corrosive environments).
- **Image Retention:** Permanent image damage caused by the prolonged display of static content.
- **Traceability:** Removal, alteration, or defacement of the product serial number.

## 9.3 Limitation of Liability

Limitation of liability, exclusions, remedies, and any applicable liability caps are governed exclusively by the applicable Beetrronics Terms and Conditions referenced at the time of purchase.

The applicable Terms and Conditions are those of the contracting seller entity identified on the purchase invoice and may vary by jurisdiction.

Beetrronics shall not be responsible for the performance, safety, or regulatory compliance of any system into which the display component is integrated, except as expressly provided in the applicable Terms and Conditions.

## 9.4 Service and Support Contacts

For technical support, warranty claims, or regulatory inquiries, contact the appropriate Beetrionics entity for your region.

Offices		
<b>Austria</b>	0720 115 767	<a href="http://www.beetronics.at">www.beetronics.at</a>
<b>Belgium</b>	03 808 1603	<a href="http://www.beetronics.be">www.beetronics.be</a>
<b>Denmark</b>	89 88 42 29	<a href="http://www.beetronics.dk">www.beetronics.dk</a>
<b>France</b>	01 79 97 48 02	<a href="http://www.beetronics.fr">www.beetronics.fr</a>
<b>Germany</b>	02113 878 95 62	<a href="http://www.beetronics.de">www.beetronics.de</a>
<b>Ireland</b>	(01) 903 6425	<a href="http://www.beetronics.ie">www.beetronics.ie</a>
<b>Italy</b>	011 1962 1372	<a href="http://www.beetronics.it">www.beetronics.it</a>
<b>Netherlands</b>	020 - 700 83 66	<a href="http://www.beetronics.nl">www.beetronics.nl</a>
<b>Norway</b>	21 63 00 02	<a href="http://www.beetronics.no">www.beetronics.no</a>
<b>Poland</b>	022 397 04 43	<a href="http://www.beetronics.pl">www.beetronics.pl</a>
<b>Spain</b>	911 981 024	<a href="http://www.beetronics.es">www.beetronics.es</a>
<b>Sweden</b>	0844-680 783	<a href="http://www.beetronics.se">www.beetronics.se</a>
<b>Switzerland</b>	043 50 80 772	<a href="http://www.beetronics.ch">www.beetronics.ch</a>
<b>U.K.</b>	020 3608 7495	<a href="http://www.beetronics.co.uk">www.beetronics.co.uk</a>
<b>US</b>	(323) 433-1644	<a href="http://www.beetronics.com">www.beetronics.com</a>
<b>CA</b>	647-557-7931	<a href="http://www.beetronics.ca">www.beetronics.ca</a>
<b>Safety &amp; Compliance</b>	+31 20 24 46 365	<a href="mailto:safety@beetronics.com">safety@beetronics.com</a>

10

Appendix

# Public Compliance Statement

Beetronics  
Public Compliance Statement

**Version:** 1.5

**Last updated:** January 2026

## Manufacturer & Regulatory Contact Information

### Manufacturer (EU & Global)

Beetronics B.V.

Bloemstraat 28, 1016 LC Amsterdam, The Netherlands

### US Responsible Party (FCC)

Beetronics Inc.

2093 Philadelphia Pike #4945, Claymont, DE 19703, United States

### Contact:

info@beetronics.com | www.beetronics.com

## Product Applicability

This statement applies to the following Beetronics display product families, supplied as **unintegrated professional display components**:

**Monitor Series:** 7HD7M to 32HD7M

**Touchscreen Series:** 7TS7M/U1 to 32TS7M/U1

**High Brightness Series:** 10HB9M/U1 to 27HB9M/U1

## 1. Scope and Responsibility

This document applies exclusively to Beetronics products supplied at component level. It does not represent approval, certification, or suitability of any complete system or end-use application (including vehicles, vessels, medical devices, or other regulated systems). Final system compliance, risk analysis, and regulatory approval remain the responsibility of the system integrator, OEM, or end manufacturer, in line with standard industry practice for modular components.

Unless formally agreed in writing, Beetronics products are not intended for use as life-supporting or safety-critical components. This statement does not constitute system-level certification, end-use approval, or a warranty of fitness for a specific application. It is intended to support and facilitate professional system integration and system-level certification activities.

## 2. General Regulatory and Safety Framework

Representative samples of applicable product families have been evaluated against, or designed with the objective of meeting, the following regulatory frameworks, where applicable:

<b>European Union</b>	<b>CE Marking</b> <ul style="list-style-type: none"><li>• Electromagnetic Compatibility Directive 2014/30/EU</li><li>• Low Voltage Directive 2014/35/EU</li><li>• RoHS Directive 2015/863/EU</li></ul>
<b>United Kingdom</b>	<b>UKCA Marking</b> <ul style="list-style-type: none"><li>• Electromagnetic Compatibility Regulations 2016</li><li>• Electrical Equipment (Safety) Regulations 2016</li><li>• Restriction of the Use of Certain Hazardous Substances Regulations 2012</li></ul>
<b>United States</b>	<b>FCC</b> <ul style="list-style-type: none"><li>• 47 CFR Part 15</li><li>• 47 CFR Part 18</li></ul>
<b>Canada</b>	<b>ISED</b> <ul style="list-style-type: none"><li>• RCM</li><li>• ICES-003</li></ul>
<b>Australia / New Zealand</b>	<b>ANSI C63.4</b> <ul style="list-style-type: none"><li>• Applicable AS/NZS CISPR EMC standards and recognised electrical safety requirements</li></ul>

## 3. Environmental and Substance Considerations

Based on current assessments, supplier declarations, and available documentation at the time of manufacture and supply, representative product samples have been evaluated with respect to:

<b>RoHS</b>	EU Directive 2015/863/EU
<b>REACH</b>	Regulation (EC) No. 1907/2006, SVHC status-based
<b>WEEE</b>	Covered under applicable registration and take-back obligations where required.  This product must not be disposed of with unsorted municipal waste. As professional electronic equipment, it must be collected and processed separately in accordance with applicable waste electrical and electronic equipment (WEEE) regulations. For information on approved collection, return, or take-back options, please contact your local Beetronics office.
<b>California Proposition 65</b>	Evaluated against applicable disclosure requirements.
<b>Conflict Minerals (3TG)</b>	Addressed through supplier-level declarations where applicable.

REACH obligations are dynamic; material status is assessed based on the regulatory framework in force at the time of manufacture and supply.

## 4. Conditions and Evaluation Methodology

The following section provides additional detail on the conditions and methodology under which the above compliance framework applies.

### 4.1 Delivered Configuration and Modifications

Compliance evaluations described in this statement apply to products in their delivered configuration, as defined in applicable test reports, certifications, and technical documentation. This statement does not extend to:

- mechanical or electrical modification of the product,
- opening or alteration of the housing,
- firmware or software modification,
- use of non-Beetronics power supplies, except where explicitly specified (e.g. PSU1-MAR, PSU1-MED),
- integration with third-party equipment outside evaluated configurations.

For projects requiring custom integration or modification, Beetronics can provide technical information and pre-evaluation guidance upon request. Any modified configuration remains subject to separate compliance assessment.

#### **4.2 Environmental and Installation Factor**

Environmental conditions, installation methods, enclosure design, cabling, grounding, and system-level certifications are outside the scope of this statement and are addressed at system level by the integrator.

#### **4.3 Representative / Family Testing**

Compliance assessments are conducted on representative models within each product family. Test results are applied to equivalent models sharing identical electrical, mechanical, thermal, and EMC-relevant design characteristics. This methodology aligns with established industry practice for scalable and modular display platforms.

### **5. How to Use This Statement**

This Public Compliance Statement is intended to support:

- engineering evaluation,
- procurement and sourcing decisions,
- component-level compliance assessment.

It does not replace system-level certification, regulatory approval, or risk analysis required for the final application.

### **6. Statement of Conformance**

Beetronics states that representative samples of the products covered by this document have been designed, manufactured, and evaluated at component level in alignment with the referenced regulatory frameworks and standards, subject to the defined scope, methodology, conditions, and limitations.

### **7. Integration and Documentation Support**

Beetronics maintains detailed test reports, evaluations, and supporting compliance documentation for the product families listed in this statement. Where required for engineering review, audits, or system-level certification activities, relevant documentation can be made available upon request. Provision of such documentation does not alter the scope or responsibility allocation defined in this statement.

### **Important Information**

This document is provided for informational purposes to support professional evaluation and procurement. It does not constitute a warranty, guarantee, or certification of end-use suitability. All sales are subject to the Beetronics General Terms and Conditions.

Hereby, Beetronics declares that the products covered by this manual comply with the applicable EU directives. The full text of the EU Declaration of Conformity is available upon request or via the Beetronics website.

**Issued by:** Beetronics Compliance Department

**Document type:** Public Compliance Statement

**Version:** 1.5

**Last updated:** January 2026